

# Plan snitt og fasader

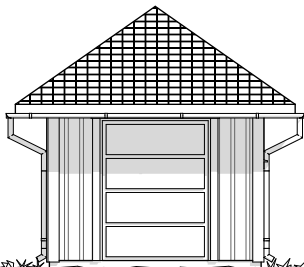

Fasade 1

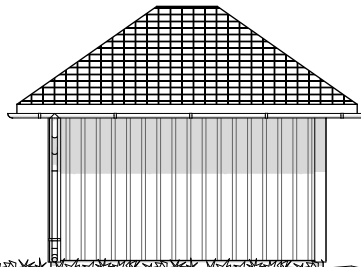

Fasade 2

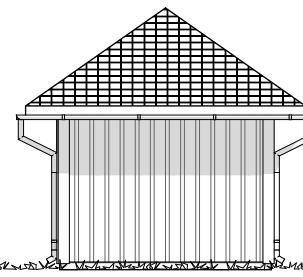

Fasade 3

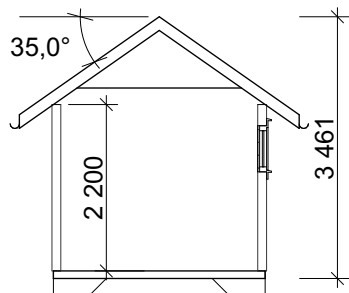

Snitt A-A

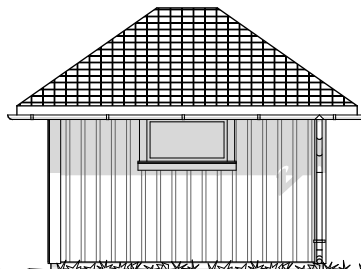

Fasade 4

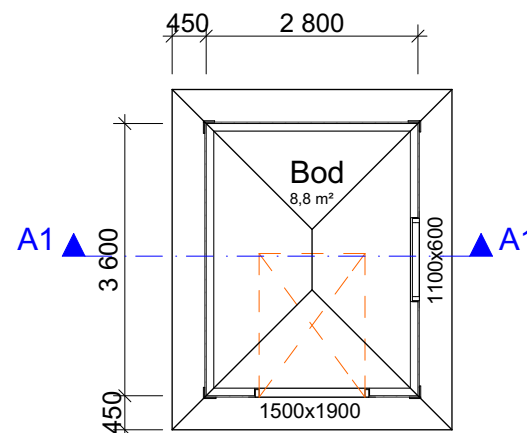

Plan

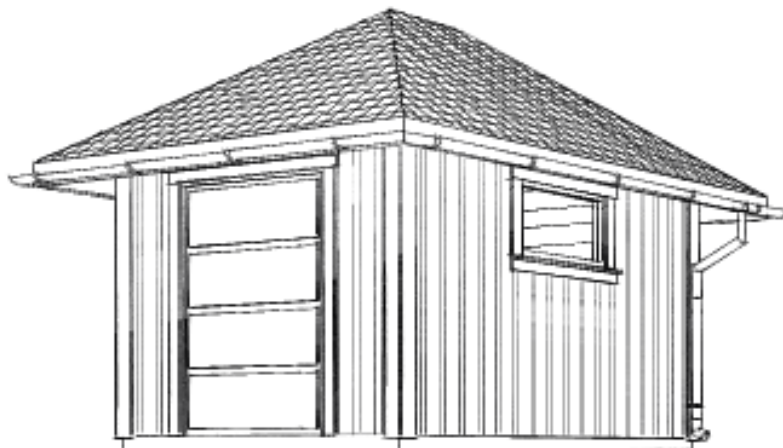

MINIGARASJEN

- Plass til mer -

MODELL			
280x360 - 35° valmtak - stående kledning			
SIST ENDRET	MÅLESTOKK	BRA	BYA
30.11.2020	1:100	8,8m <sup>2</sup>	10,1m <sup>2</sup>
KOPIERING ELLER ULOVLIG BRUK AV TEGNINGEN MEDFØRER ERSTATNINGSANSVAR			